

Data sheet | Item number: 261-423/331-000

2-conductor terminal strip; 3-pole; on one side with push-buttons; with fixing flanges; for screw or similar mounting types; Fixing hole 3.2 mm Ø; 2.5 mm²; CAGE CLAMP®

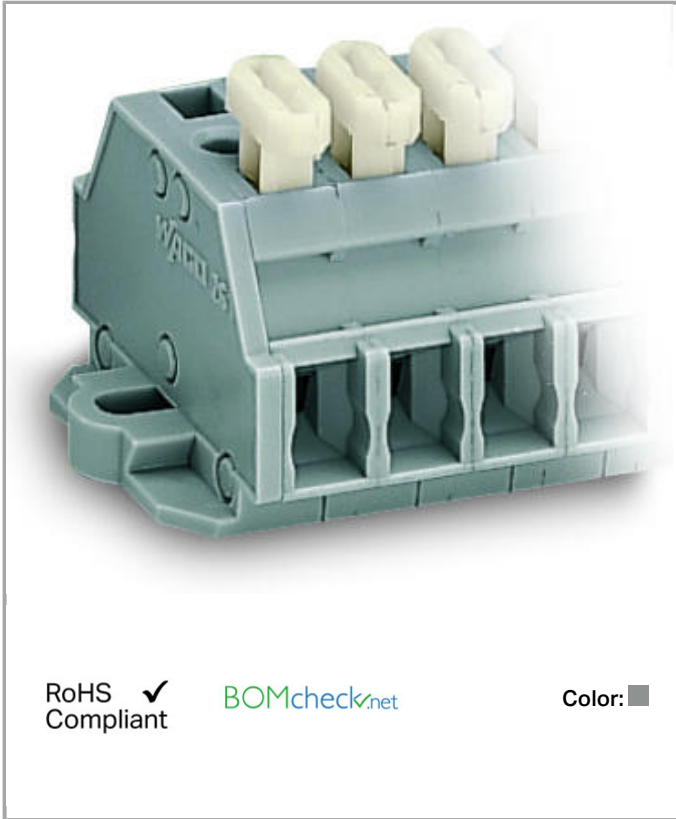

261-423/331-000



RoHS Compliant

[BOMcheck.net](https://www.bomcheck.net)

Color: ■

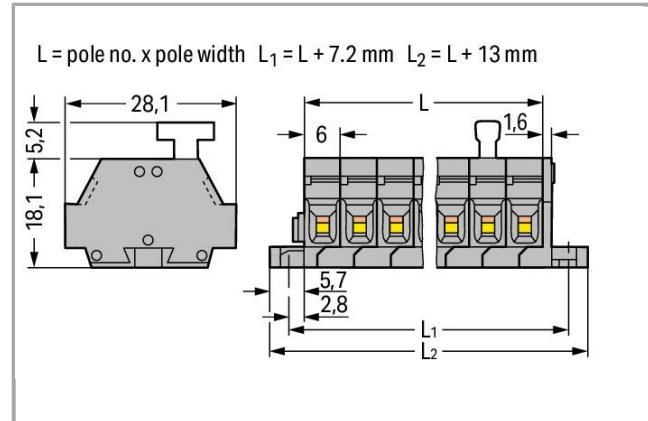

Data

Electrical data

Ratings per IEC/EN 60664-1

Rated voltage (III / 3)	500 V
Rated impulse voltage (III / 3)	6 kV
Rated current	24 A

Connection data

Connection technology	CAGE CLAMP®
Actuation type	Operating tool Push-button
Connectable conductor materials	Copper
Solid conductor	0.08 ... 2.5 mm ² / 28 ... 14 AWG
Fine-stranded conductor	0.08 ... 2.5 mm ² / 28 ... 14 AWG
Strip length	8 ... 9 mm / 0.31 ... 0.35 inch

No. of poles	3
Total number of connection points	6
Total number of potentials	3
Number of levels	1
Type of wiring	Side-entry wiring

Geometrical Data

Width	31.6 mm / 1.244 inch
Height from the surface	23.2 mm / 0.913 inch
Depth	28 mm / 1.102 inch
Module width	6 mm / 0.236 inch

Mechanical data

Design	horizontal
Mounting type	Mounting flange
Marking level	Side marking

Material Data

Color	gray
Fire load	0.177 MJ
Weight	8.701 g

Commercial data

Country of origin	DE
GTIN	4044918626798
Customs Tariff No.	85369010000

Compatible products

assembling



Item no.: 209-137
Mounting adapter; can be used as end plate; 6.5 mm wide

209-137

check



Item no.: 210-136
Test plug; 2 mm Ø; with 500 mm cable

210-136

General accessories

**Item no.: 209-123**

Mounting foot with screw; can be screwed on terminal blocks with fixing flange; 6.4 mm wide

209-123

tools**Item no.: 209-132**

Operating tool; for connecting comb-style jumper bar; 2-way; of insulating material

209-132

**Item no.: 210-657**

Operating tool with partially insulated shaft; Blade (3.5 x 0.5) mm; short

210-657

**Item no.: 210-658**

Operating tool with partially insulated shaft; Blade (3.5 x 0.5) mm; short; angled

210-658

**Item no.: 210-720**

Operating tool with partially insulated shaft; Type 2, blade (3.5 x 0.5) mm

210-720

Marking accessories**Item no.: 2009-145**

Mini-WSB Inline; for Smart Printer; on reel; stretchable 5 - 5.2 mm; plain; snap-on type

2009-145

**Item no.: 2009-145/000-002**

Mini-WSB Inline; for Smart Printer; on reel; stretchable 5 - 5.2 mm; plain; snap-on type

2009-145

/000-002

**Item no.: 2009-145/000-005**

Mini-WSB Inline; for Smart Printer; on reel; stretchable 5 - 5.2 mm; plain; snap-on type

2009-145

/000-005

**Item no.: 2009-145/000-006**

Mini-WSB Inline; for Smart Printer; on reel; stretchable 5 - 5.2 mm; plain; snap-on type

2009-145

/000-006

**Item no.: 2009-145/000-007**

Mini-WSB Inline; for Smart Printer; on reel; stretchable 5 - 5.2 mm; plain; snap-on type

2009-145

/000-007

**Item no.: 2009-145/000-012**

Mini-WSB Inline; for Smart Printer; on reel; stretchable 5 - 5.2 mm; plain; snap-on type

2009-145

/000-012

**Item no.: 2009-145/000-023**

Mini-WSB Inline; for smartPRINTER; on reel; stretchable 5 - 5.2 mm; plain; snap-on type

2009-145

/000-023

**Item no.: 2009-145/000-024**

Mini-WSB Inline; for Smart Printer; on reel; stretchable 5 - 5.2 mm; plain; snap-on type

2009-145

/000-024

**Item no.: 248-501**

Miniature WSB Quick marking system; plain; Marker width 5 mm; 10 strips with 10 markers per card

248-501

**Item no.: 248-501/000-002**

Mini-WSB marking card; as card; not stretchable; plain; snap-on type

248-501

















/000-002















**Item no.: 248-501/000-005**

Mini-WSB marking card; as card; not stretchable; plain; snap-on type

248-501

/000-005

	Item no.: 248-501/000-006 Mini-WSB marking card; as card; not stretchable; plain; snap-on type	/000-006	248-501
	Item no.: 248-501/000-007 Mini-WSB marking card; as card; not stretchable; plain; snap-on type	/000-007	248-501
	Item no.: 248-501/000-012 Mini-WSB marking card; as card; not stretchable; plain; snap-on type	/000-012	248-501
	Item no.: 248-501/000-017 Mini-WSB marking card; as card; not stretchable; plain; snap-on type	/000-017	248-501
	Item no.: 248-501/000-023 Mini-WSB marking card; as card; not stretchable; plain; snap-on type	/000-023	248-501
	Item no.: 248-501/000-024 Mini-WSB marking card; as card; not stretchable; plain; snap-on type	/000-024	248-501
ferrule			
	Item no.: 216-101 Ferrule; Sleeve for 0.5 mm ² / AWG 22; uninsulated; electro-tin plated		216-101
	Item no.: 216-102 Ferrule; Sleeve for 0.75 mm ² / AWG 20; uninsulated; electro-tin plated		216-102
	Item no.: 216-103 Ferrule; Sleeve for 1 mm ² / AWG 18; uninsulated; electro-tin plated		216-103
	Item no.: 216-104 Ferrule; Sleeve for 1.5 mm ² / AWG 16; uninsulated; electro-tin plated		216-104
	Item no.: 216-106 Ferrule; Sleeve for 2.5 mm ² / AWG 14; uninsulated; electro-tin plated		216-106
	Item no.: 216-121 Ferrule; Sleeve for 0.5 mm ² / AWG 22; uninsulated; electro-tin plated		216-121
	Item no.: 216-122 Ferrule; Sleeve for 0.75 mm ² / AWG 20; uninsulated; electro-tin plated		216-122
	Item no.: 216-123 Ferrule; Sleeve for 1 mm ² / AWG 18; uninsulated; electro-tin plated		216-123
	Item no.: 216-124 Ferrule; Sleeve for 1.5 mm ² / AWG 16; uninsulated; electro-tin plated		216-124
	Item no.: 216-131 Ferrule; Sleeve for 0.25 mm ² / AWG 24; uninsulated; electro-tin plated		216-131
	Item no.: 216-132 Ferrule; Sleeve for 0.34 mm ² / AWG 24; uninsulated; electro-tin plated		216-132

	Item no.: 216-151 Ferrule; Sleeve for 0.25 mm ² / AWG 24; uninsulated; electro-tin plated	216-151
	Item no.: 216-152 Ferrule; Sleeve for 0.34 mm ² / AWG 24; uninsulated; electro-tin plated	216-152
	Item no.: 216-201 Ferrule; Sleeve for 0.5 mm ² / 20 AWG; insulated; electro-tin plated	216-201
	Item no.: 216-202 Ferrule; Sleeve for 0.75 mm ² / 18 AWG; insulated; electro-tin plated	216-202
	Item no.: 216-203 Ferrule; Sleeve for 1 mm ² / AWG 18; insulated; electro-tin plated	216-203
	Item no.: 216-204 Ferrule; Sleeve for 1.5 mm ² / AWG 16; insulated; electro-tin plated	216-204
	Item no.: 216-205 Ferrule; Sleeve for 2.08 mm ² / AWG 14; insulated; electro-tin plated	216-205
	Item no.: 216-206 Ferrule; Sleeve for 2.5 mm ² / AWG 14; insulated; electro-tin plated	216-206
	Item no.: 216-221 Ferrule; Sleeve for 0.5 mm ² / 20 AWG; insulated; electro-tin plated	216-221
	Item no.: 216-222 Ferrule; Sleeve for 0.75 mm ² / 18 AWG; insulated; electro-tin plated	216-222
	Item no.: 216-223 Ferrule; Sleeve for 1 mm ² / AWG 18; insulated; electro-tin plated	216-223
	Item no.: 216-224 Ferrule; Sleeve for 1.5 mm ² / AWG 16; insulated; electro-tin plated	216-224
	Item no.: 216-301 Ferrule; Sleeve for 0.25 mm ² / AWG 24; insulated; electro-tin plated	216-301
	Item no.: 216-302 Ferrule; Sleeve for 0.34 mm ² / 22 AWG; insulated; electro-tin plated	216-302
	Item no.: 216-321 Ferrule; Sleeve for 0.25 mm ² / AWG 24; insulated; electro-tin plated	216-321
	Item no.: 216-322 Ferrule; Sleeve for 0.34 mm ² / 22 AWG; insulated; electro-tin plated	216-322
Jumper		
	Item no.: 261-402 Comb-style jumper bar; insulated; 2-way; reduces conductor size to 1.5 mm	261-402

Downloads

Documentation

Bid Text

261-423/331-000



doc	Download
25.1 kB	

CAD/CAE - Smart Data

CAD data

3D Download 261-423/331-000	URL	Download
-----------------------------	-----	----------

Subject to changes.
